

Adult breathing systems for transport ventilators



Critical Care ▪ Breathing Systems

Adult breathing systems for transport ventilators

We offer a range of disposable adult transport breathing systems for use with the majority of transport ventilators for inter departmental and inter hospital patient transport or transfer. Set up ready for use, straight from the pack, they use a selection of valves and flow sensors designed and validated for the appropriate ventilators, as shown.

The Oxylog® 3000, 3000 plus and 2000 plus systems also feature an over moulded connector block for the flow sensor lines, ensuring secure connection and correct orientation of the two lines.

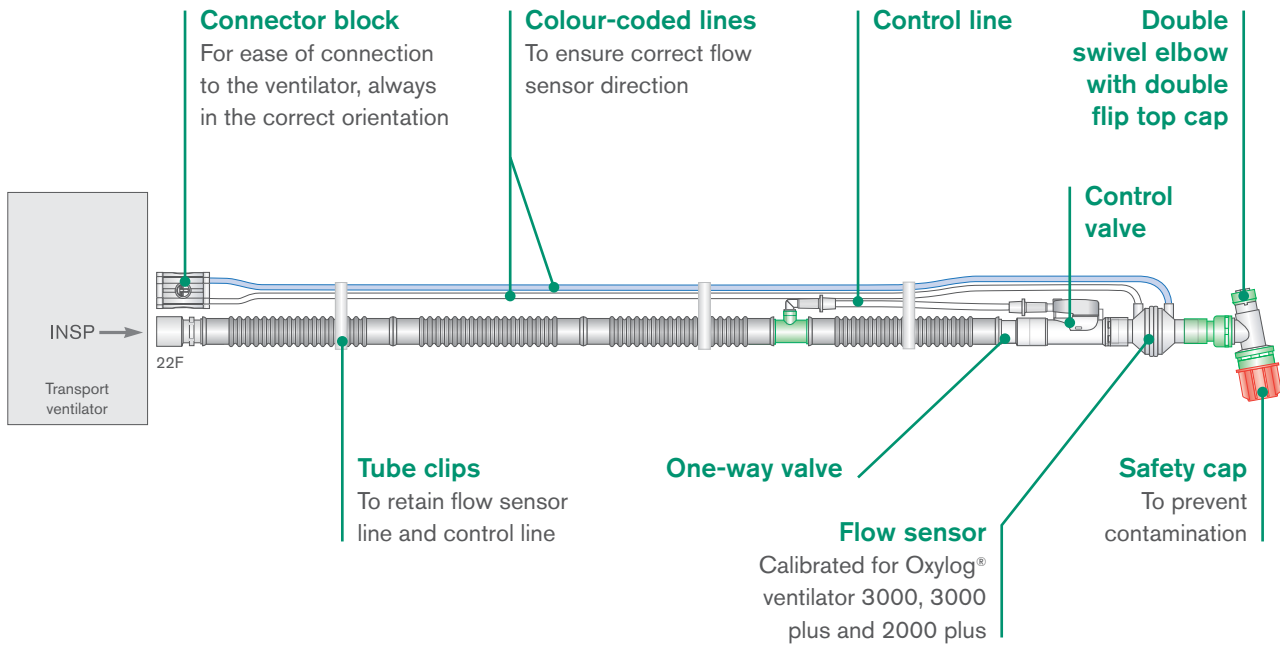

System shown is for use with Oxylog® 3000, 3000 plus and 2000 plus.





Oxylog® 3000, 3000 plus and 2000 plus

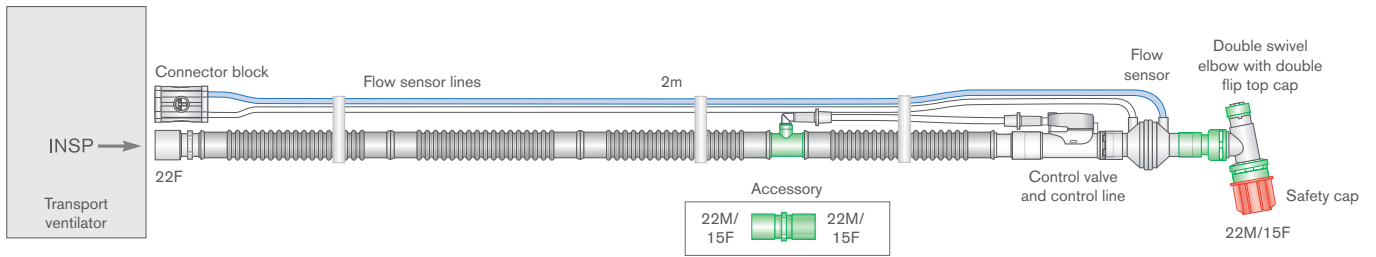

Code	Description	Box Qty.
2072000	22mm Flextube™ transport breathing system, for use with Oxylog® 3000, 3000 plus and 2000 plus, 2m	10

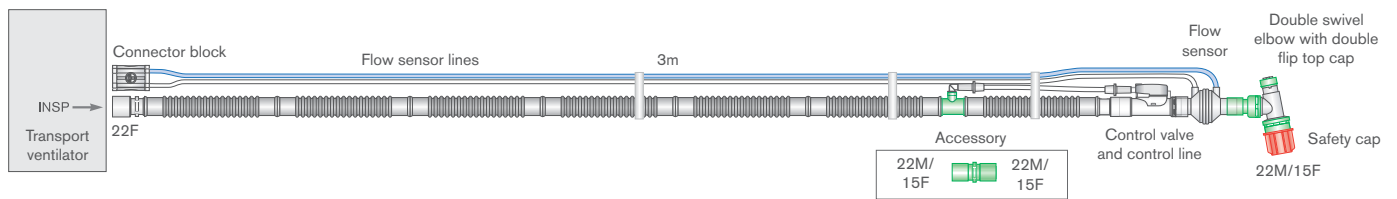

Code	Description	Box Qty.
2272000	22mm Flextube transport breathing system, for use with Oxylog® 3000, 3000 plus and 2000 plus, 3m	20

Oxylog® 1000, Pneupac® paraPAC®, ventiPAC™ and transPAC™

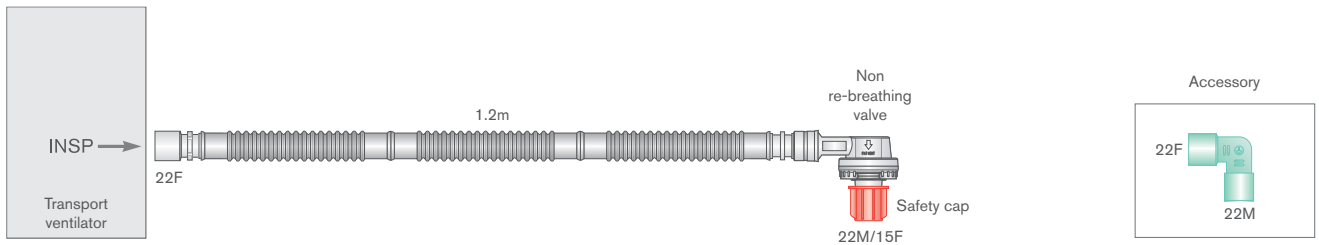

Code	Description	Box Qty.
2070000	22mm Flextube basic transport breathing system with non re-breathing valve, for use with Oxylog® 1000, Pneupac® paraPAC®, ventiPAC™ and transPAC™, 1.2m	12

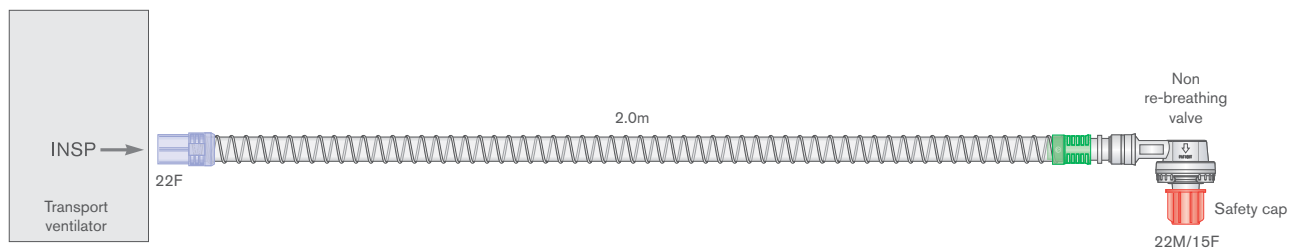

Code	Description	Box Qty.
5020002	22mm Smoothbore basic transport breathing system with non re-breathing valve, for use with Oxylog® 1000, Pneupac® paraPAC®, ventiPAC™ and transPAC™, 2m	10

Pneupac® paraPAC®, ventiPAC™ and transPAC™

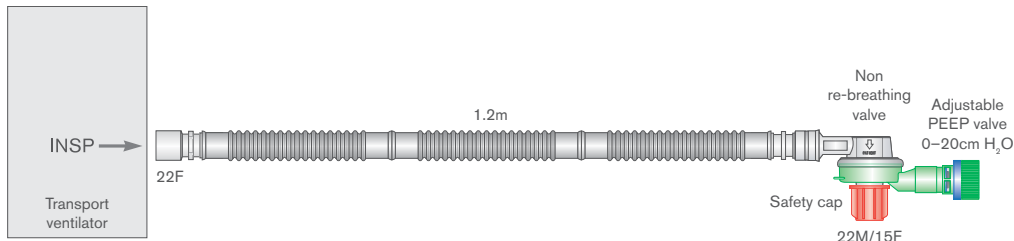

Code	Description	Box Qty.
2073000	22mm Flextube transport breathing system with non re-breathing valve and adjustable PEEP valve, for use with Pneupac® paraPAC®, ventiPAC™ and transPAC™, 1.2m	12

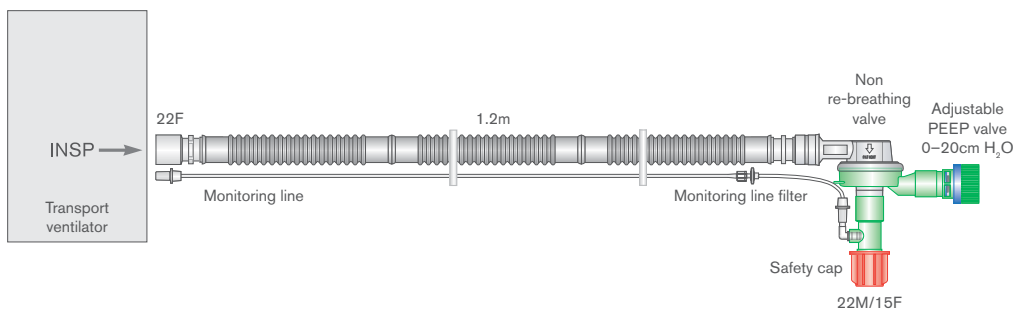

Code	Description	Box Qty.
2074000	22mm Flextube transport breathing system with non re-breathing valve, adjustable PEEP valve and monitoring line with filter, for use with Pneupac® transPAC™, 1.2m	15

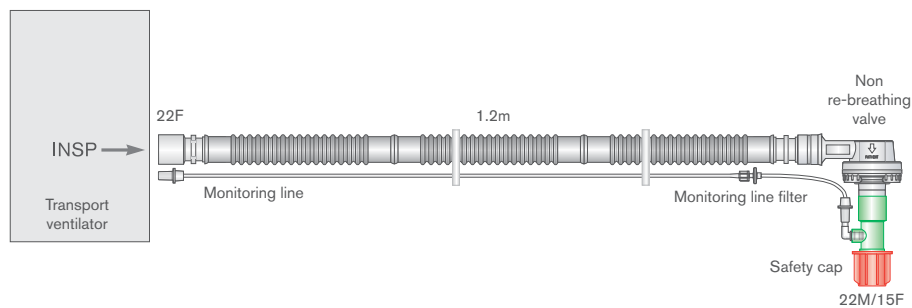

Code	Description	Box Qty.
2075000	22mm Flextube transport breathing system with non re-breathing valve and monitoring line with filter, for use with Pneupac® transPAC™, 1.2m	15

Make an enquiry

Oxylog is a registered trademark of Dräger Medical GmbH.

Pneupac, transPAC, Pneupac ventiPAC, Pneupac paraPAC are trademarks of the Smiths Medical family of companies.



Intersurgical Ltd, Crane House, Molly Millars Lane, Wokingham, Berkshire, RG41 2RZ, UK
 T: +44 (0)118 9656 300 F: +44 (0)118 9656 356 info@intersurgical.com www.intersurgical.com



The manufacturer Intersurgical Ltd is certified to ISO 9001:2008, ISO 13485:2003 and ISO 14001:2015

Please think before you print
 Save energy and paper.
 If you must print this information sheet please print it double sided.